

Model of Computation



Arijit Mondal

Dept. of Computer Science & Engineering
Indian Institute of Technology Patna

`arijit@iitp.ac.in`

Introduction

- Big systems are developed by composing elements
- Need to handle concurrent composition
- Actor composition
 - Actor can be FSM, hardware, code, etc.
- Three things need to be defined while composing elements
 - List of components
 - Concurrency mechanism
 - Communication mechanism

Components

- An actor with input, output ports and a set of execution actions
 - Port will be interconnected to provide communication between actors
 - Execution action will be invoked by environment

Structure of model

- Fixed interconnection
- Communication takes place through signals
 - Discrete signal
 - Continuous signal

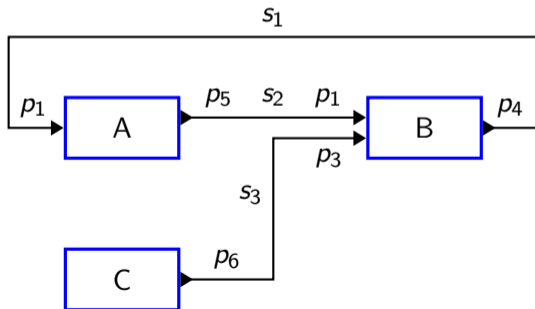

System of equations for actor network

- If actor is determinate, then actor is a function that maps input to output
- For example
 - $s_2 = A(s_1)$
 - $s_1 = B(s_2, s_3)$
 - $s_3 = C(\emptyset)$
 - For a system, $s' = F(s)$
- Fixed point
 - Given any function $F : X \rightarrow X$ for any set X , if there is an $x \in X$ such that $x = F(x)$ then x is called fixed point
 - Existence of fixed point
 - Uniqueness of fixed point
 - Procedure for finding fixed point

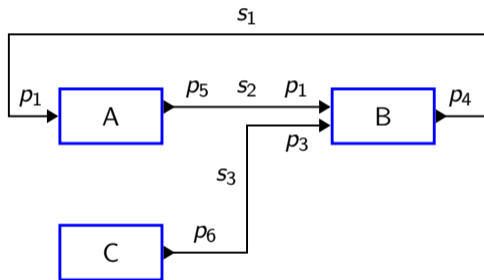

Synchronous reactive model

- Need to know inputs at the time of reaction
- But it is the same as output
 - Circular dependency
- Synchronous reactive (SR) model of computation is proposed
 - Signals are absent at all time except at ticks of a global clock
 - Execution of a model is a sequence of global reactions that occur at discrete time
 - Reaction of all actors is simultaneous and instantaneous

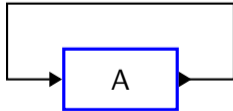

Feedback model

- Given the current state determine the value of s
- If machine is in s_1 then $a_{s_1} = absent$
 - a_{s_1} is the firing function in state s_1
- We are looking for $s(n) = a_i(s(n))$;

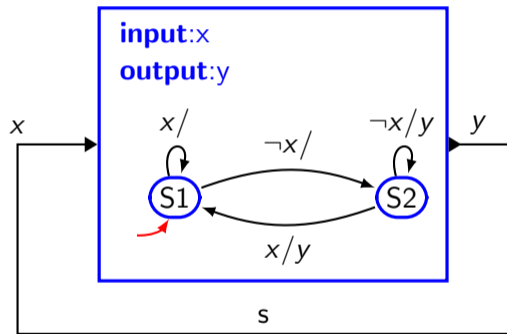

Semantics

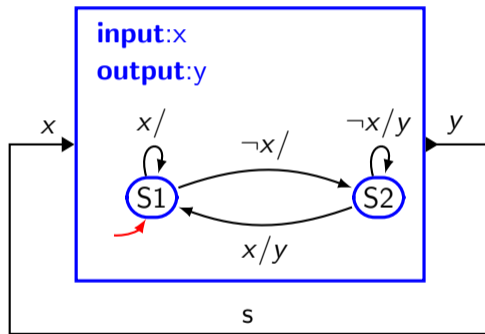

Semantics

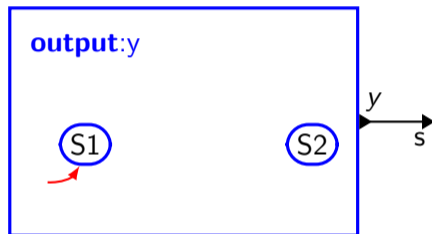
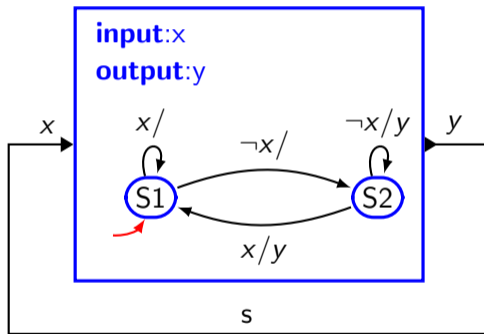

Semantics

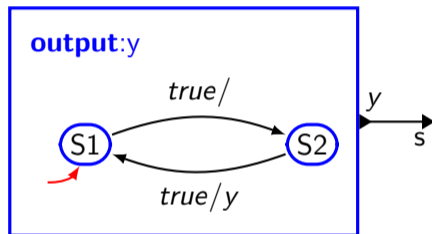
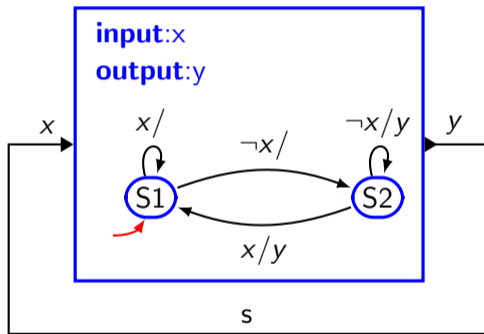

III formed

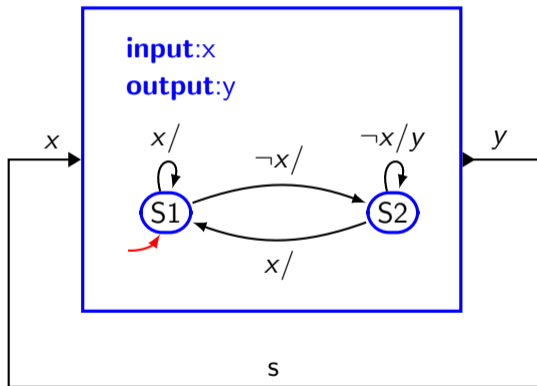

Non-unique fixed point

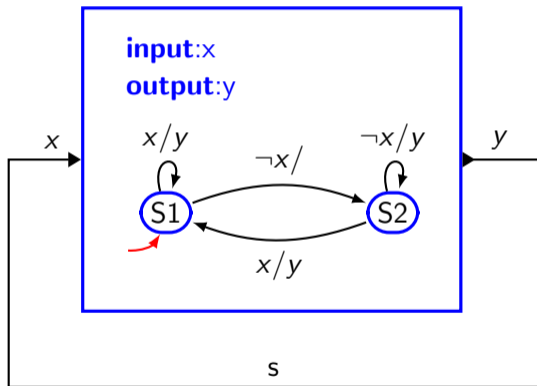

Constructing a fixed point

- Start with $s(n)$ unknown
- Determine as much as possible about $f_i(s(n))$ using only firing function
- Repeat above step until all values in $s(n)$ become known
- If unknown remains, then reject the model

Not constructive

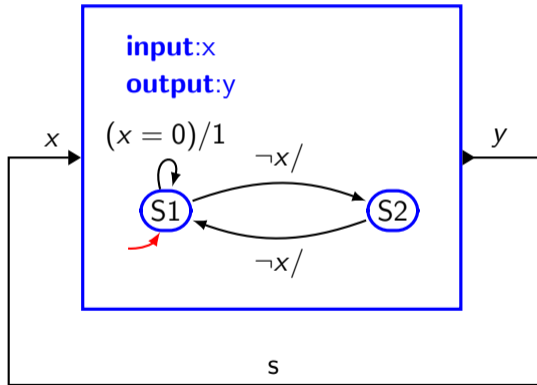

Synchronous dataflow model

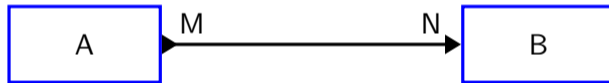

Synchronous dataflow model

